

Standards and documents applied:

LST EN ISO 4064-1:2017/A11/2023;
LST EN ISO 4064-2:2017/A11/2023;
LST EN ISO 4064-4:2014;
LST EN ISO 4064-5:2017/A11/2023;
OIML R 49-1:2024;
OIML R 49-2:2024;
WELMEC 7.2:2023.

The measuring instrument must correspond with the following specifications:

1 Design of the instrument

1.1 Construction

Ultrasonic complete water meter QALCOSONIC W1 consists of a measurement transducer with a primary flow sensor, an electronic calculator and indicating device. Plastic measuring sections with two ultrasonic transducers are installed in the plastic meter body (for meters with threaded end connection G 2 and flanges DN50 – with four ultrasonic transducers). A filter strainer can be installed in the meter inlet. A non-return valve can be installed in the meter outlet (except for meters with threaded end connection G ¾ length 80 mm, G 1 length 105 mm and 110 mm, G 1½ and flanges DN50). The meter has an electronic calculator and a LCD indicating device mounted in the same body.

The meter, depending on the modification, is designed to measure forward flow or forward and reverse flow. The volume passed during reverse flow is registered in a separate register and additionally can be subtracted from the volume of the forward flow.

The meter is powered by a non-replaceable 3,6 V DC lithium battery (one or two).



a) A design



b) B design

Fig.1. Water meter QALCOSONIC W1, $Q_3 = 1,6/2,5/4,0 \text{ m}^3/\text{h}$, with threaded end connection G ¾ or G 1



Fig. 2. Water meter QALCOSONIC W1,
 $Q_3 = 6,3/10 \text{ m}^3$, with threaded end connection
G 1¼ or G 1½



Fig. 3. Water meter QALCOSONIC W1,
 $Q_3 = 10/16/25 \text{ m}^3$, with threaded
end connection G2



Fig. 4. Water meter QALCOSONIC W1,
 $Q_3 = 16/25/40 \text{ m}^3$, with flanges DN50

1.2 Sensor

Ultrasonic flow sensor.

1.3 Measurement value processing

The flow measurement principle is based on the measurement of ultrasonic signal propagation time on the downstream and upstream of water flow. The difference between the measuring times is proportional to the water flow through the meter, which is calculated by the meter calculator.

1.4 Indication of the measurement results

Measured volume of water is indicated on the two-line LCD indicating device.

Upper line: 9 columns, intended for volume of water, passing through the meter.

Indications in operating mode: m^3 , three digits after decimal point.

Indications in TEST mode : m^3 , six digits after decimal point.

Lower line: 5 columns for displaying current flow in m^3/h and information symbols.

1.5 Optional equipment and functions subject to MID requirements

None.

1.6 Technical documentation

Smart ultrasonic water meter QALCOSONIC W1. Technical description, installation manual and user guide: QW1_V17.X_EN, 06-01-2025.

Assembly drawing N10.0001.00.00-01, 07-12-2021.

Assembly drawing N10.0013.00.00-01, 24-08-2018.

Assembly drawing N14.0010.00.00-00, 01-10-2020.

Assembly drawing N10.0033.00.00-00, 01-10-2020.

Assembly drawing N14.013.00.00 W1 DN40 L300, 11-12-2020.

Assembly drawing N10.0052.100.00-00, 15-10-2021.

Assembly drawing N10.0052.100.00-00, 15-10-2021.

Assembly drawing N10.0043.00.00-00, 13-02-2024.

Other reference documents on which the basis this certificate is issued are stored in file No. LEI-12-MP-002.25.

1.7 Integrated equipment and functions not subject to MID

NFC (near-field communication) interface is integrated in the meter, intended for data reading. The optical interface according to requirements of EN 62056-21 is integrated in the meter, intended for data reading via M-Bus protocol, for meter parameters setting and for optical pulses output.

The meter is equipped with one of the following wireless communication interfaces:

- RF 868 MHz;
- RF 433 MHz;
- RF 915 MHz;
- RF 920,5 MHz;
- NB-IoT, frequency bands B1, B3, B5, B8, B20, B28.

Data via RF communication interfaces may be transmitted using the following protocols:

- W-M-Bus-T1;
- W-M-Bus-T2;
- LoRa WAN;
- CoAP.

The meter can be equipped (optional, only for meters with threaded end connection G2 and flanges DN50) with one or both of the following additional wired communication interfaces (cable length 1,5 m):

- M-Bus;
- wired pulse output.

2 Technical data

2.1 Rated operating conditions

2.1.1 Measurand

The volume of water passing through the meter, indicated on the LCD indicator.

2.1.2 Measurement range

The measurement range of the water meter QALCOSONIC W1 and other technical characteristics are presented in table 1:

Table 1

Flowrate, m ³ /h				The ratio <i>R</i> , Q_3/Q_1	End connections	Overall length <i>L</i> , mm	Pressure loss class: without filter/ with filter strainer
Q_3	Q_4	Q_1	Q_2				
1,6	2,0	0,0200	0,0320	80	G ¾	80 ¹ ; 105 ¹ ; 110; 115 ¹ ; 165;170	For forward and reverse flow: Δp 16/ Δp 16
		0,0100	0,0160	160			
		0,0064	0,0102	250			
		0,0051	0,0081	315			
		0,0040	0,0064	400			
2,5	3,125	0,0313	0,0500	80	G ¾	80 ¹ ; 105 ¹ ; 110; 115 ¹ ; 165;170	For forward flow: Δp 25/ Δp 25 For reverse flow: Δp 25/ Δp 40
		0,0156	0,0250	160			
		0,0100	0,0160	250			
		0,0063	0,0100	400			
		0,0050	0,0080	500			
		0,0031	0,0050	800			

Q_3	Flowrate, m ³ /h		The ratio $R, Q_3/Q_1$	End connections	Overall length L, mm	Pressure loss class: without filter/ with filter strainer	
	Q_4	Q_1					Q_2
2,5	3,125	0,0313	0,0500	80	G 1	105; 110 ¹ ; 130; 165; 190	For forward and reverse flow: $\Delta p 16/ \Delta p 16$
		0,0156	0,0250	160			
		0,0100	0,0160	250			
		0,0063	0,0100	400			
4,0	5,0	0,0500	0,0800	80	G 1	105; 110 ¹ ; 130; 165; 190	For forward flow: $\Delta p 25/ \Delta p 40^2$ For reverse flow: $\Delta p 25/ \Delta p 40$
		0,0250	0,0400	160			
		0,0160	0,0256	250			
		0,0100	0,0160	400			
		0,0080	0,0128	500			
		0,0050	0,0080	800			
6,3	7,875	0,0788	0,1260	80	G 1¼	260	For forward and reverse flow: $\Delta p 25/ \Delta p 40$
		0,0394	0,0630	160			
		0,0252	0,0403	250			
		0,0158	0,0252	400			
		0,0126	0,0202	500			
		0,0079	0,0126	800 ³			
6,3	7,875	0,0788	0,1260	80	G 1½	260	For forward and reverse flow: $\Delta p 16/ \Delta p 16$
		0,0394	0,0630	160			
		0,0252	0,0403	250			
		0,0158	0,0252	400			
10	12,5	0,1250	0,2000	80	G 1¼	260	For forward flow: $\Delta p 63/ \Delta p 63$ For reverse flow: $\Delta p 63/ -^4$
		0,0625	0,1000	160			
		0,0400	0,0640	250			
		0,0250	0,0400	400			
		0,0200	0,0320	500			
		0,0125	0,0200	800 ³			
		0,0100	0,0160	1000 ³			
10	12,5	0,1250	0,2000	80	G 1½	260	For forward and reverse flow: $\Delta p 25/ \Delta p 25$
		0,0625	0,1000	160			
		0,0250	0,0400	400			
		0,0200	0,0320	500			
		0,0125	0,0200	800 ³			
10	12,5	0,1250	0,2000	80	G2	300	For forward and reverse flow: $\Delta p 16/ \Delta p 16$
		0,0625	0,1000	160			
		0,0400	0,0640	250			
16,0	20,0	0,2000	0,3200	80	G 2	300	For forward and reverse flow: $\Delta p 16/ \Delta p 16$
		0,1000	0,1600	160			
		0,0640	0,1024	250			
		0,0400	0,0640	400			
		0,0320	0,0512	500			
		0,0200	0,0320	800 ³			
25,0	31,25	0,3125	0,5000	80	G 2	300	For forward and reverse flow: $\Delta p 16/ \Delta p 25$
		0,1563	0,2500	160			
		0,1000	0,1600	250			
		0,0625	0,1000	400			
		0,0500	0,0800	500			
		0,0313	0,0500	800 ³			

Flowrate, m ³ /h				The ratio <i>R</i> , Q_3/Q_1	End connections	Overall length <i>L</i> , mm	Pressure loss class: without filter/ with filter strainer
Q_3	Q_4	Q_1	Q_2				
16,0	20,0	0,2000	0,3200	80	DN50	200	For forward and reverse flow: Δp 16/ Δp 25
		0,1000	0,1600	160			
		0,0640	0,1024	250			
		0,0400	0,0640	400 ³			
25,0	31,25	0,3125	0,5000	80	DN50	200	For forward and reverse flow: Δp 25/ Δp 63
		0,1563	0,2500	160			
		0,1000	0,1600	250			
		0,0625	0,1000	400			
		0,0500	0,0800	500			
		0,0313	0,0500	800 ³			
40,0	50,0	0,5000	0,8000	80	DN50	200	For forward and reverse flow: Δp 63 ⁵
		0,2500	0,4000	160			
		0,1600	0,2560	250			
		0,1000	0,1600	400			
		0,0800	0,1280	500			
		0,0500	0,0800	800 ³			

Notes:

¹ – meters are produced only in the A design version.

² – for meters $Q_3 = 4$ m³/h, threaded end connection G 1, $l = 190$ mm, when installed the filter strainer, the pressure loss class Δp 40 is valid. For all other lengths of meters $Q_3 = 4$ m³/h with filter, the pressure loss class Δp 25 applies.

³ – this ratio is only valid for meters with temperature class T30.

⁴ – meters $Q_3 = 10$ m³/h, threaded end connection G 1¼ and with reverse flow measurement function are installed only without filter-strainer.

⁵ – meters DN50, $Q_3 = 40$ m³/h are installed only without filter strainer.

2.1.3 Meter temperature classes and maximum permissible errors

Meter temperature classes and maximum permissible errors are presented in table 2:

Table 2

Meter temperature class	Water temperature ranges	Maximum permissible errors
T30	between 0,1 °C and 30 °C	± 5 % in flow range $Q_1 \leq Q < Q_2$ ± 2 % in flow range $Q_2 \leq Q \leq Q_4$
T50	between 0,1 °C and 50 °C	± 5 % in flow range $Q_1 \leq Q < Q_2$ ± 2 % in flow range $Q_2 \leq Q \leq Q_4$ (for water temperature between 0,1 °C and 30 °C) ± 3 % in flow range $Q_2 \leq Q \leq Q_4$ (for water temperature between 30 °C and 50 °C)
T30/90	between 30 °C and 90 °C	± 5 % in flow range $Q_1 \leq Q < Q_2$ ± 3 % in flow range $Q_2 \leq Q \leq Q_4$
T90	between 0,1 °C and 90 °C	± 5 % in flow range $Q_1 \leq Q < Q_2$ ± 2 % in flow range $Q_2 \leq Q \leq Q_4$ (for water temperature between 0,1 °C and 30 °C) ± 3 % in flow range $Q_2 \leq Q \leq Q_4$ (for water temperature between 30 °C and 90 °C)

2.1.4 Environmental conditions / Influence quantities

Ambient working temperature	:	-15 °C to 70 °C;
Humidity level	:	condensing;
Installations	:	indoor or outdoor;
Electromagnetic environment	:	class E2;
Degree of protection	:	IP65 or IP68.

2.2 Other operating conditions

2.2.1 Maximum admissible working pressure

The maximum admissible working pressure of a water meter is 1,6 MPa (MAP 16).

2.2.2 Mounting position of the water meter

Water meter can be mounted either horizontally, vertically or inclined.

3 Interfaces and compatibility conditions

The communication interfaces of the meter are described in section 1.7 of this appendix.

4 Requirements on production, putting into use and utilization

4.1 Requirements for production

At the end of the manufacturing and adjustment process the water meters shall be tested according to the requirements of the EN ISO 4064-2, section 10.1. Errors of water meters shall not exceed the maximum permissible errors, described in Annex III (MI-001) of the Directive 2014/32/EU.

The meters shall be tested within each of the following flowrates:

between Q_1 and $1,1Q_1$;

between Q_2 and $1,1Q_2$;

between $0,9Q_3$ and Q_3 .

For meters class T30 and T50: water temperature of tests $20\text{ °C} \pm 10\text{ °C}$.

For meters class T30/90: water temperature of tests is $50\text{ °C} \pm 10\text{ °C}$.

For meters class T90: water temperature of tests $20\text{ °C} \pm 10\text{ °C}$ and $50\text{ °C} \pm 10\text{ °C}$.

4.2 Requirements for putting into use

The water meter QALCOSONIC W1 must be installed in accordance with the requirements of technical description specified in section 1.6.

The straight pipelines in upstream and downstream the meter is not necessary (flow profile sensitivity class U0 D0).

4.3 Requirements for consistent utilization

No special requirements identified.

5 Checking of instruments which are in operation

5.1 Documented procedure

None.

5.2 Special equipment or software

- optical reading head according to standard LST EN 62056-21, with special holder;

- service software **Meter Configurator**.

5.3 Identification of hardware and software

5.3.1 Identification of hardware

- see Fig.1– Fig. 4 of this appendix.

5.3.2 Identification of software

Depending on the software version, the version number may be marked on the meter label or displayed on the meter indicating device.

5.3.2.1 Software versions marked on the meter label

Software versions marked on the meter label:

- for meters with threaded end connection G $\frac{3}{4}$, G 1, G $1\frac{1}{4}$, G $1\frac{1}{2}$: **1.01** or **1.03**, when the Renesas RF10WMGAFB microcontroller is used, **3.01** when the Nuvoton M258KE3AE microcontroller is used or **4.01**, when the Renesas R5F111PJGFB microcontroller is used,
- for meters with threaded end connection G 2 and flanges DN50: **2.02**, when the Renesas RF10WMGAFB microcontroller is used or **4.01**, when the Renesas R5F111PJGFB microcontroller is used.

The version number indicated on the device's label is marked as SW:1.01, SW:1.03, SW:3.01, SW:2.02 or SW:4.01. For these versions, the meter's checksum CRC is read using auxiliary equipment - an optical head and special software „W1 CRC Reader“. After pressing „Start“ the „uint16 (HEX)“ variable is read from the 0x103C address, and the CRC value is displayed. CRC values are provided in Annex 2p.

5.3.2.2 Software versions displayed on the meter indicating device

The software version number and CRC checksum are periodically displayed on the meter's LCD indicating device (Table 3).

Table 3

Software version	CRC*	Description
1.03.01	4dbEdF32	LoRa EU868, A design, G $\frac{3}{4}$ – G $1\frac{1}{2}$, microcontroller Renesas R5F10WMGAFB
4.01.01	29C951C9	LoRa EU868, G 2 – DN50, microcontroller Renesas R5F111PJGFB
1.03.02	7D79F7E3	LoRa EU868, B design, G $\frac{3}{4}$ – G 1, microcontroller Renesas R5F10WMGAFB
4.01.03	08205FC3	NB-IoT, A design, B design, G $\frac{3}{4}$ – G $1\frac{1}{2}$, microcontroller Renesas R5F111PJGFB
4.01.04	4CE18891	NB-IoT, G 2 – DN50, microcontroller Renesas R5F111PJGFB

* – the „uint32“(HEX) variable is read from 0x103C address.

5.4 Calibration/adjustment procedure

Using an optical head and a computer with Windows based software – **Meter Configurator** platform, the meter verification mode (TEST) is activated. Optical head should be connected to the computer USB interface. A computer must be connected to the Internet to use the platform.

With the help of a special holder, after placing the optical head on the meter and opening the login window of the application, enter the username and password provided by the Axioma Metering's technical support. Clicking the „Login“ button opens the „Pick a product“ window, where „QW1“ is selected. When the „Optical Communication Settings (QW1)“ window opens, in the „Serial Port“ field, enter the number of the computer port to which the optical head is connected (if the connection does not occur automatically). Click the „Confirm“ button and the „Meter Information (QW1)“ window opens. After clicking the „Enable Test Mode“ button, the meter enters the TEST mode, in which the resolution of the meter volume readings is 1 ml.

The meter's measurement errors shall be evaluated at the reference flow rates indicated in section 4.1 of this appendix. Optical pulse output of the meter is used or volume indications can be read directly from meter's LCD.

The volume pulse value in TEST mode is presented in table 3.

Table 3

Permanent flowrate Q_3 of the meter, m ³ /h	Volume pulse value in verification mode (TEST), litre/pulse
1,6	0,001
2,5	0,002
4	0,004
6,3	0,005
10	0,010
16	0,015
25	0,020
40	0,025

The meter is put into operating mode by pressing the „Disable Test Mode“ button in the „Meter Information (QW1)“ window.

The meter returns to its operating mode itself, 24 hours after activation of the TEST mode.

The TEST mode in the meter can also be enabled/disabled using an Android smartphone with the **Meter Configurator** platform installed. The platform can be downloaded from the Google Play Store. In this case, the optical head is not needed, the communication is ensured through the NFC interface.

6 Security measures

6.1 Sealing

The meter casing is imperceptibly closed. Any unauthorized opening of the housing is impossible without damaging. When the upper cover is opened, the safety button that is installed in the meter body is activated and the error code appears on the meter display, with the first digit „4“.

Holes in the meter body are provided for sealing the meter with threaded end connection after installation (Fig. 5 a and b).

For meter with flanges DN50, the mounting screws are sealed after installation (Fig. 5 c).

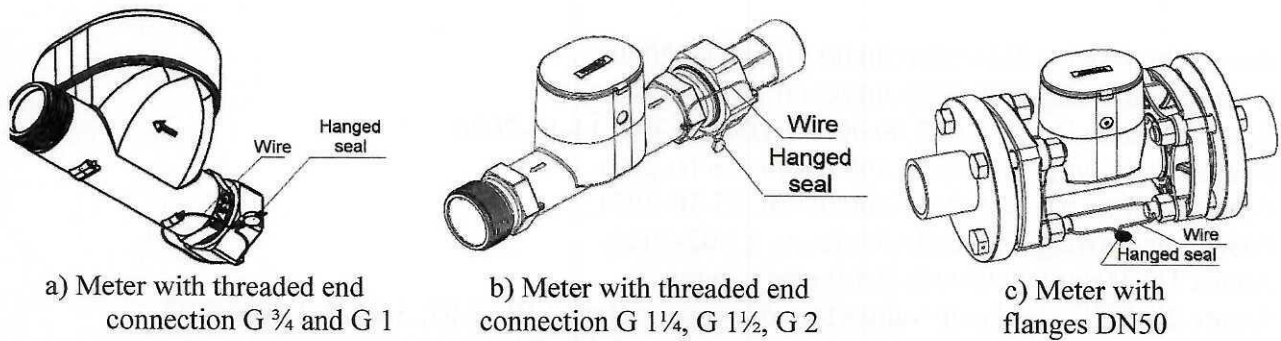

Fig. 5. Sealing of the water meter QALCOSONIC W1 after installation

7 Marking and inscriptions

7.1 Information to be borne by and to accompany the measuring instrument

The water meter housing cover contains the following information:

- EU-type examination certificate number;
- trade mark of the manufacturer;
- distributor's logo (if applicable);
- type designation of the meter;
- year of manufacture and serial number;
- unit of measurement: m^3 (on LCD display);
- permanent flowrate Q_3 ;
- the ratio Q_3/Q_1 , preceded by „R“;
- the temperature class, where it differs from T30;
- the maximum admissible working pressure (MAP);
- pressure loss class;
- the installation sensitivity class of the meter;
- the latest date by which the meter shall be replaced;
- software version number (when the version number is marked on the meter label);
- IP code;
- QR code or barcode;
- communication interface NB-IoT (optional, if installed in the meter).
- LoRa (optional, when using the LoRa WAN data transfer protocol);
- UKCA mark (optional).

Arrow to indicate the direction of the flow shall appear on flow sensor body.

7.2 Conformity marking

In addition, the label of water meter should contain the following marking:

- „CE” marking;
- supplementary metrology marking, consisting of the capital letter „M” and the last two digits of the year of its affixing, surrounded by a rectangle;
- the number of the notified body that carried out the conformity assessment.

8 List of the drawings attached to the certificate

Assembly drawing N10.0001.00.00-01, 07-12-2021.

Assembly drawing N10.0013.00.00-01, 24-08-2018.

Assembly drawing N14.0010.00.00-00, 01-10-2020.
 Assembly drawing N10.0033.00.00-00, 01-10-2020.
 Assembly drawing N14.013.00.00 W1 DN40 L300, 11-12-2020.
 Assembly drawing N10.0052.100.00-00, 15-10-2021.
 Assembly drawing N10.0055.100.00-00, 15-10-2021.
 Assembly drawing N10.0043.00.00-00, 13-02-2024.
 Annex 1p: Meter labels with distributor's logos.
 Annex 2p: CRC checksum values for software versions 1.01; 1.03; 3.01; 4.01 and 2.02.

9 Certificate history

Issue	Date and reference No.	Description																																																				
1	2	3																																																				
LT-1621-MI001-034	31-08-2018, No. LEI-12-MP-076.18	Type examination certificate first issued.																																																				
LT-1621-MI001-034 Revision 1	30-07-2019, No. LEI-12-MP-088.19	1. The meter has been supplemented with water temperature class T50. 2. The design of the meter marking label has been changed (Fig. 1) 3. The document PL_QW1_V02, issued 29-08-2018, has been replaced by the document PL_QW1_V04, issued 24-07-2019.																																																				
LT-1621-MI001-034 Revision 2	09-12-2019, No. LEI-12-MP-092.19	1. The meter has been supplemented by new modifications with extended flow measurement limits: <table border="1" data-bbox="571 1106 1469 1514"> <thead> <tr> <th colspan="4">Flowrate, m³/h</th> <th rowspan="2">R, Q₃/Q₁</th> <th rowspan="2">End connections</th> <th rowspan="2">Overall length L, mm</th> <th rowspan="2">Pressure loss class</th> </tr> <tr> <th>Q₃</th> <th>Q₄</th> <th>Q₁</th> <th>Q₂</th> </tr> </thead> <tbody> <tr> <td rowspan="5">1,6</td> <td rowspan="5">2,0</td> <td rowspan="5">0,004</td> <td rowspan="5">0,0064</td> <td rowspan="5">400</td> <td>G ¾</td> <td>80</td> <td>ΔP 25</td> </tr> <tr> <td>G ¾</td> <td>105</td> <td>ΔP 25</td> </tr> <tr> <td>G ¾</td> <td>110</td> <td>ΔP 25</td> </tr> <tr> <td>G ¾</td> <td>165</td> <td>ΔP 25</td> </tr> <tr> <td>G ¾</td> <td>170</td> <td>ΔP 25</td> </tr> <tr> <td rowspan="5">2,5</td> <td rowspan="5">3,125</td> <td rowspan="5">0,0031</td> <td rowspan="5">0,005</td> <td rowspan="5">800</td> <td>G ¾</td> <td>80</td> <td>ΔP 40</td> </tr> <tr> <td>G ¾</td> <td>105</td> <td>ΔP 40</td> </tr> <tr> <td>G ¾</td> <td>110</td> <td>ΔP 40</td> </tr> <tr> <td>G ¾</td> <td>165</td> <td>ΔP 40</td> </tr> <tr> <td>G ¾</td> <td>170</td> <td>ΔP 40</td> </tr> </tbody> </table> 2. New meter labeling drawings with distributor's NeoVac logo. 3. The document PL_QW1_V04, issued 24-07-2019, has been replaced by the document PL_QW1_V05, issued 21-08-2019.	Flowrate, m ³ /h				R, Q ₃ /Q ₁	End connections	Overall length L, mm	Pressure loss class	Q ₃	Q ₄	Q ₁	Q ₂	1,6	2,0	0,004	0,0064	400	G ¾	80	ΔP 25	G ¾	105	ΔP 25	G ¾	110	ΔP 25	G ¾	165	ΔP 25	G ¾	170	ΔP 25	2,5	3,125	0,0031	0,005	800	G ¾	80	ΔP 40	G ¾	105	ΔP 40	G ¾	110	ΔP 40	G ¾	165	ΔP 40	G ¾	170	ΔP 40
Flowrate, m ³ /h				R, Q ₃ /Q ₁	End connections	Overall length L, mm					Pressure loss class																																											
Q ₃	Q ₄	Q ₁	Q ₂																																																			
1,6	2,0	0,004	0,0064	400	G ¾	80	ΔP 25																																															
					G ¾	105	ΔP 25																																															
					G ¾	110	ΔP 25																																															
					G ¾	165	ΔP 25																																															
					G ¾	170	ΔP 25																																															
2,5	3,125	0,0031	0,005	800	G ¾	80	ΔP 40																																															
					G ¾	105	ΔP 40																																															
					G ¾	110	ΔP 40																																															
					G ¾	165	ΔP 40																																															
					G ¾	170	ΔP 40																																															
LT-1621-MI001-034 Revision 3	31-01-2020, No. LEI-12-MP-098.20	1. The meter may additionally equipped with the following wireless communication interfaces: <ul style="list-style-type: none"> - RF 920,5 MHz; - NB-IoT, frequency bands B1, B3, B5, B8, B20, B28. 2. The document PL_QW1_V05, issued 21-08-2019, has been replaced by the document PL_QW1_V06, issued 09-01-2020.																																																				



1	2	3																																																																																																																																																																				
<p>LT-1621-MI001-034 Revision 4</p>	<p>25-08-2020, No. LEI-12- MP-106.20</p>	<p>1. The meter has been supplemented by modifications with additional values of the ratio $R(Q_3/Q_1) = 80$ and $R(Q_3/Q_1) = 160$.</p> <p>2. For meters with end connections G $\frac{3}{4}$ and permanent flowrate $Q_3 = 1,6 \text{ m}^3/\text{h}$, pressure-loss class has been changed from $\Delta p 25$ to $\Delta p 16$.</p> <p>3. For meters with end connections G $\frac{3}{4}$ and permanent flowrate $Q_3 = 2,5 \text{ m}^3/\text{h}$, pressure-loss class has been changed from $\Delta p 40$ to $\Delta p 25$.</p> <p>4. Meter marking labels with the logos of new distributors (Annex 1p).</p> <p>5. The document PL_QW1_V06, issued 09-01-2020, has been replaced by the document PL_QW1_V08, issued 22-07-2020.</p>																																																																																																																																																																				
<p>LT-1621-MI001-034 Revision 5</p>	<p>25-08-2020, No. LEI-12- MP-106.20</p>	<p>1. The meter has been supplemented with the following new modifications:</p> <table border="1" data-bbox="624 925 1519 1626"> <thead> <tr> <th colspan="4">Flowrate, m^3/h</th> <th rowspan="2">R, Q_3/Q_1</th> <th rowspan="2">End connections</th> <th rowspan="2">Overall length L, mm</th> <th rowspan="2">Pressure loss class</th> </tr> <tr> <th>Q_3</th> <th>Q_4</th> <th>Q_1</th> <th>Q_2</th> </tr> </thead> <tbody> <tr><td>6,3</td><td>7,875</td><td>0,079</td><td>0,126</td><td>80</td><td>G $1\frac{1}{4}$</td><td>260</td><td>$\Delta p 25$</td></tr> <tr><td>6,3</td><td>7,875</td><td>0,040</td><td>0,063</td><td>160</td><td>G $1\frac{1}{4}$</td><td>260</td><td>$\Delta p 25$</td></tr> <tr><td>6,3</td><td>7,875</td><td>0,0252</td><td>0,040</td><td>250</td><td>G $1\frac{1}{4}$</td><td>260</td><td>$\Delta p 25$</td></tr> <tr><td>6,3</td><td>7,875</td><td>0,016</td><td>0,0252</td><td>400</td><td>G $1\frac{1}{4}$</td><td>260</td><td>$\Delta p 25$</td></tr> <tr><td>6,3</td><td>7,875</td><td>0,008</td><td>0,013</td><td>800*</td><td>G $1\frac{1}{4}$</td><td>260</td><td>$\Delta p 25$</td></tr> <tr><td>6,3</td><td>7,875</td><td>0,079</td><td>0,126</td><td>80</td><td>G $1\frac{1}{2}$</td><td>260</td><td>$\Delta p 16$</td></tr> <tr><td>6,3</td><td>7,875</td><td>0,040</td><td>0,063</td><td>160</td><td>G $1\frac{1}{2}$</td><td>260</td><td>$\Delta p 16$</td></tr> <tr><td>6,3</td><td>7,875</td><td>0,0252</td><td>0,040</td><td>250</td><td>G $1\frac{1}{2}$</td><td>260</td><td>$\Delta p 16$</td></tr> <tr><td>6,3</td><td>7,875</td><td>0,016</td><td>0,0252</td><td>400</td><td>G $1\frac{1}{2}$</td><td>260</td><td>$\Delta p 16$</td></tr> <tr><td>10,0</td><td>12,5</td><td>0,125</td><td>0,200</td><td>80</td><td>G $1\frac{1}{4}$</td><td>260</td><td>$\Delta p 63$</td></tr> <tr><td>10,0</td><td>12,5</td><td>0,0625</td><td>0,100</td><td>160</td><td>G $1\frac{1}{4}$</td><td>260</td><td>$\Delta p 63$</td></tr> <tr><td>10,0</td><td>12,5</td><td>0,040</td><td>0,064</td><td>250</td><td>G $1\frac{1}{4}$</td><td>260</td><td>$\Delta p 63$</td></tr> <tr><td>10,0</td><td>12,5</td><td>0,025</td><td>0,040</td><td>400</td><td>G $1\frac{1}{4}$</td><td>260</td><td>$\Delta p 63$</td></tr> <tr><td>10,0</td><td>12,5</td><td>0,0125</td><td>0,020</td><td>800*</td><td>G $1\frac{1}{4}$</td><td>260</td><td>$\Delta p 63$</td></tr> <tr><td>10,0</td><td>12,5</td><td>0,010</td><td>0,016</td><td>1000*</td><td>G $1\frac{1}{4}$</td><td>260</td><td>$\Delta p 63$</td></tr> <tr><td>10,0</td><td>12,5</td><td>0,125</td><td>0,200</td><td>80</td><td>G $1\frac{1}{2}$</td><td>260</td><td>$\Delta p 25$</td></tr> <tr><td>10,0</td><td>12,5</td><td>0,0625</td><td>0,100</td><td>160</td><td>G $1\frac{1}{2}$</td><td>260</td><td>$\Delta p 25$</td></tr> <tr><td>10,0</td><td>12,5</td><td>0,025</td><td>0,040</td><td>400</td><td>G $1\frac{1}{2}$</td><td>260</td><td>$\Delta p 25$</td></tr> <tr><td>10,0</td><td>12,5</td><td>0,0125</td><td>0,020</td><td>800*</td><td>G $1\frac{1}{2}$</td><td>260</td><td>$\Delta p 25$</td></tr> </tbody> </table> <p>Note: * – this ratio is only valid for meters with temperature class T30.</p> <p>2. Meter version with additional wired M-Bus or pulse output communication interface has been removed.</p> <p>3. For meters with end connections G 1 and permanent flowrate $Q_3 = 2,5 \text{ m}^3/\text{h}$, pressure-loss class has been changed from $\Delta p 25$ to $\Delta p 16$.</p> <p>4. For meters with end connections G 1 and permanent flowrate $Q_3 = 4,0 \text{ m}^3/\text{h}$, pressure-loss class has been changed from $\Delta p 40$ to $\Delta p 25$.</p> <p>5. Additional technical description for meters $Q_3 = 6,3 \text{ m}^3/\text{h}$ and $Q_3 = 10 \text{ m}^3/\text{h}$: PL_QW1DN25-32_V01, issued 19-10-2020.</p>	Flowrate, m^3/h				R, Q_3/Q_1	End connections	Overall length L, mm	Pressure loss class	Q_3	Q_4	Q_1	Q_2	6,3	7,875	0,079	0,126	80	G $1\frac{1}{4}$	260	$\Delta p 25$	6,3	7,875	0,040	0,063	160	G $1\frac{1}{4}$	260	$\Delta p 25$	6,3	7,875	0,0252	0,040	250	G $1\frac{1}{4}$	260	$\Delta p 25$	6,3	7,875	0,016	0,0252	400	G $1\frac{1}{4}$	260	$\Delta p 25$	6,3	7,875	0,008	0,013	800*	G $1\frac{1}{4}$	260	$\Delta p 25$	6,3	7,875	0,079	0,126	80	G $1\frac{1}{2}$	260	$\Delta p 16$	6,3	7,875	0,040	0,063	160	G $1\frac{1}{2}$	260	$\Delta p 16$	6,3	7,875	0,0252	0,040	250	G $1\frac{1}{2}$	260	$\Delta p 16$	6,3	7,875	0,016	0,0252	400	G $1\frac{1}{2}$	260	$\Delta p 16$	10,0	12,5	0,125	0,200	80	G $1\frac{1}{4}$	260	$\Delta p 63$	10,0	12,5	0,0625	0,100	160	G $1\frac{1}{4}$	260	$\Delta p 63$	10,0	12,5	0,040	0,064	250	G $1\frac{1}{4}$	260	$\Delta p 63$	10,0	12,5	0,025	0,040	400	G $1\frac{1}{4}$	260	$\Delta p 63$	10,0	12,5	0,0125	0,020	800*	G $1\frac{1}{4}$	260	$\Delta p 63$	10,0	12,5	0,010	0,016	1000*	G $1\frac{1}{4}$	260	$\Delta p 63$	10,0	12,5	0,125	0,200	80	G $1\frac{1}{2}$	260	$\Delta p 25$	10,0	12,5	0,0625	0,100	160	G $1\frac{1}{2}$	260	$\Delta p 25$	10,0	12,5	0,025	0,040	400	G $1\frac{1}{2}$	260	$\Delta p 25$	10,0	12,5	0,0125	0,020	800*	G $1\frac{1}{2}$	260	$\Delta p 25$
Flowrate, m^3/h				R, Q_3/Q_1	End connections	Overall length L, mm					Pressure loss class																																																																																																																																																											
Q_3	Q_4	Q_1	Q_2																																																																																																																																																																			
6,3	7,875	0,079	0,126	80	G $1\frac{1}{4}$	260	$\Delta p 25$																																																																																																																																																															
6,3	7,875	0,040	0,063	160	G $1\frac{1}{4}$	260	$\Delta p 25$																																																																																																																																																															
6,3	7,875	0,0252	0,040	250	G $1\frac{1}{4}$	260	$\Delta p 25$																																																																																																																																																															
6,3	7,875	0,016	0,0252	400	G $1\frac{1}{4}$	260	$\Delta p 25$																																																																																																																																																															
6,3	7,875	0,008	0,013	800*	G $1\frac{1}{4}$	260	$\Delta p 25$																																																																																																																																																															
6,3	7,875	0,079	0,126	80	G $1\frac{1}{2}$	260	$\Delta p 16$																																																																																																																																																															
6,3	7,875	0,040	0,063	160	G $1\frac{1}{2}$	260	$\Delta p 16$																																																																																																																																																															
6,3	7,875	0,0252	0,040	250	G $1\frac{1}{2}$	260	$\Delta p 16$																																																																																																																																																															
6,3	7,875	0,016	0,0252	400	G $1\frac{1}{2}$	260	$\Delta p 16$																																																																																																																																																															
10,0	12,5	0,125	0,200	80	G $1\frac{1}{4}$	260	$\Delta p 63$																																																																																																																																																															
10,0	12,5	0,0625	0,100	160	G $1\frac{1}{4}$	260	$\Delta p 63$																																																																																																																																																															
10,0	12,5	0,040	0,064	250	G $1\frac{1}{4}$	260	$\Delta p 63$																																																																																																																																																															
10,0	12,5	0,025	0,040	400	G $1\frac{1}{4}$	260	$\Delta p 63$																																																																																																																																																															
10,0	12,5	0,0125	0,020	800*	G $1\frac{1}{4}$	260	$\Delta p 63$																																																																																																																																																															
10,0	12,5	0,010	0,016	1000*	G $1\frac{1}{4}$	260	$\Delta p 63$																																																																																																																																																															
10,0	12,5	0,125	0,200	80	G $1\frac{1}{2}$	260	$\Delta p 25$																																																																																																																																																															
10,0	12,5	0,0625	0,100	160	G $1\frac{1}{2}$	260	$\Delta p 25$																																																																																																																																																															
10,0	12,5	0,025	0,040	400	G $1\frac{1}{2}$	260	$\Delta p 25$																																																																																																																																																															
10,0	12,5	0,0125	0,020	800*	G $1\frac{1}{2}$	260	$\Delta p 25$																																																																																																																																																															



1	2	3																																																																																																												
LT-1621- MI001-034 Revision 6	21-01-2021, No. LEI-12- MP-111.21	<p>1. The meter has been supplemented with the following new modifications with threaded end connection G2:</p> <table border="1" data-bbox="534 398 1436 878"> <thead> <tr> <th colspan="4">Flowrate, m³/h</th> <th rowspan="2">R, Q₃/Q₁</th> <th rowspan="2">End connections</th> <th rowspan="2">Overall length L, mm</th> <th rowspan="2">Pressure loss class</th> </tr> <tr> <th>Q₃</th> <th>Q₄</th> <th>Q₁</th> <th>Q₂</th> </tr> </thead> <tbody> <tr><td>10,0</td><td>12,5</td><td>0,125</td><td>0,200</td><td>80</td><td>G 2</td><td>300</td><td>Δp 16</td></tr> <tr><td>10,0</td><td>12,5</td><td>0,0625</td><td>0,100</td><td>160</td><td>G 2</td><td>300</td><td>Δp 16</td></tr> <tr><td>10,0</td><td>12,5</td><td>0,040</td><td>0,064</td><td>250</td><td>G 2</td><td>300</td><td>Δp 16</td></tr> <tr><td>16,0</td><td>20,0</td><td>0,200</td><td>0,320</td><td>80</td><td>G 2</td><td>300</td><td>Δp 16</td></tr> <tr><td>16,0</td><td>20,0</td><td>0,100</td><td>0,160</td><td>160</td><td>G 2</td><td>300</td><td>Δp 16</td></tr> <tr><td>16,0</td><td>20,0</td><td>0,064</td><td>0,102</td><td>250</td><td>G 2</td><td>300</td><td>Δp 16</td></tr> <tr><td>16,0</td><td>20,0</td><td>0,040</td><td>0,064</td><td>400</td><td>G 2</td><td>300</td><td>Δp 16</td></tr> <tr><td>25,0</td><td>31,25</td><td>0,3125</td><td>0,500</td><td>80</td><td>G 2</td><td>300</td><td>Δp 16</td></tr> <tr><td>25,0</td><td>31,25</td><td>0,156</td><td>0,250</td><td>160</td><td>G 2</td><td>300</td><td>Δp 16</td></tr> <tr><td>25,0</td><td>31,25</td><td>0,100</td><td>0,160</td><td>250</td><td>G 2</td><td>300</td><td>Δp 16</td></tr> <tr><td>25,0</td><td>31,25</td><td>0,0625</td><td>0,100</td><td>400</td><td>G 2</td><td>300</td><td>Δp 16</td></tr> <tr><td>25,0</td><td>31,25</td><td>0,0312</td><td>0,050</td><td>800*</td><td>G 2</td><td>300</td><td>Δp 16</td></tr> </tbody> </table> <p>Note: * – this ratio is only valid for meters with temperature class T30.</p> <p>2. Additional data transmission protocol CoAP for meter communication interfaces.</p> <p>3. Additional software version for meters with threaded end connection G2. The version number is 1.02.</p> <p>4. Additional technical description for meters with threaded end connection G2: PL_QW1DN40_V01, issued 20-01-2021.</p>	Flowrate, m ³ /h				R, Q ₃ /Q ₁	End connections	Overall length L, mm	Pressure loss class	Q ₃	Q ₄	Q ₁	Q ₂	10,0	12,5	0,125	0,200	80	G 2	300	Δp 16	10,0	12,5	0,0625	0,100	160	G 2	300	Δp 16	10,0	12,5	0,040	0,064	250	G 2	300	Δp 16	16,0	20,0	0,200	0,320	80	G 2	300	Δp 16	16,0	20,0	0,100	0,160	160	G 2	300	Δp 16	16,0	20,0	0,064	0,102	250	G 2	300	Δp 16	16,0	20,0	0,040	0,064	400	G 2	300	Δp 16	25,0	31,25	0,3125	0,500	80	G 2	300	Δp 16	25,0	31,25	0,156	0,250	160	G 2	300	Δp 16	25,0	31,25	0,100	0,160	250	G 2	300	Δp 16	25,0	31,25	0,0625	0,100	400	G 2	300	Δp 16	25,0	31,25	0,0312	0,050	800*	G 2	300	Δp 16
Flowrate, m ³ /h				R, Q ₃ /Q ₁	End connections	Overall length L, mm					Pressure loss class																																																																																																			
Q ₃	Q ₄	Q ₁	Q ₂																																																																																																											
10,0	12,5	0,125	0,200	80	G 2	300	Δp 16																																																																																																							
10,0	12,5	0,0625	0,100	160	G 2	300	Δp 16																																																																																																							
10,0	12,5	0,040	0,064	250	G 2	300	Δp 16																																																																																																							
16,0	20,0	0,200	0,320	80	G 2	300	Δp 16																																																																																																							
16,0	20,0	0,100	0,160	160	G 2	300	Δp 16																																																																																																							
16,0	20,0	0,064	0,102	250	G 2	300	Δp 16																																																																																																							
16,0	20,0	0,040	0,064	400	G 2	300	Δp 16																																																																																																							
25,0	31,25	0,3125	0,500	80	G 2	300	Δp 16																																																																																																							
25,0	31,25	0,156	0,250	160	G 2	300	Δp 16																																																																																																							
25,0	31,25	0,100	0,160	250	G 2	300	Δp 16																																																																																																							
25,0	31,25	0,0625	0,100	400	G 2	300	Δp 16																																																																																																							
25,0	31,25	0,0312	0,050	800*	G 2	300	Δp 16																																																																																																							
LT-1621- MI001-034 Revision 7	25-05-2021, No. LEI-12- MP-114.21	<p>1. Meter marking labels with the logos of new distributors (Annex 1p).</p> <p>2. New technical description for meters of all sizes: TM_QW1_V01_LT, issued 05-05-2021.</p>																																																																																																												
LT-1621- MI001-034 Revision 8	14-06-2021, No. LEI-12- MP-115.21	<p>1. Additional data transmission protocol W-M-Bus-T2 for meter RF communication interfaces.</p> <p>2. New software version for meters with threaded end connection G ¾, G 1, G 1¼, G 1½. The version number is 1.03.</p> <p>3. The document TM_QW1_V01_LT, issued 05-05-2021, has been replaced by the document TM_QW1_V02_LT, issued 07-06-2021.</p>																																																																																																												
LT-1621- MI001-034 Revision 9	28-10-2021, No. LEI-12- MP-119.21	<p>1. Additional design version for meters with threaded end connection G ¾ and G 1 (design version „n“).</p> <p>2. Possibility of filter strainer installation in the meter inlet. Information on pressure loss classes for meters with filter.</p>																																																																																																												



1	2	3																																																																																																																																																
		<p>3. Possibility of non-return valve installation in the meter outlet.</p> <p>4. Additional wired communication interfaces: M-Bus and/or wired pulse output (optional).</p> <p>5. Meter marking labels with the logos of new distributors (Annex 1p).</p> <p>6. The document TM_QW1_V02_LT, issued 07-06-2021, has been replaced by the document TM_QW1_V03_LT, issued 18-10-2021.</p>																																																																																																																																																
<p>LT-1621-MI001-034 Revision 10</p>	<p>10-12-2021, No. LEI-12- MP-116.21</p>	<p>1. The meter has been supplemented with the following new modifications with flanges end connection DN50:</p> <table border="1" data-bbox="614 772 1524 1339"> <thead> <tr> <th colspan="4">Flowrate, m³/h</th> <th rowspan="2">R, Q₃/Q₁</th> <th rowspan="2">End connections</th> <th rowspan="2">Length L, mm</th> <th rowspan="2">Pressure loss class: without filter/ with filter strainer</th> </tr> <tr> <th>Q₃</th> <th>Q₄</th> <th>Q₁</th> <th>Q₂</th> </tr> </thead> <tbody> <tr><td>16</td><td>20,0</td><td>0,200</td><td>0,320</td><td>80</td><td>DN50</td><td>200</td><td>Δp 16/ Δp 16</td></tr> <tr><td>16</td><td>20,0</td><td>0,100</td><td>0,160</td><td>160</td><td>DN50</td><td>200</td><td>Δp 16/ Δp 16</td></tr> <tr><td>16</td><td>20,0</td><td>0,064</td><td>0,102</td><td>250</td><td>DN50</td><td>200</td><td>Δp 16/ Δp 16</td></tr> <tr><td>16</td><td>20,0</td><td>0,040</td><td>0,064</td><td>400*</td><td>DN50</td><td>200</td><td>Δp 16/ Δp 16</td></tr> <tr><td>25</td><td>31,25</td><td>0,3125</td><td>0,500</td><td>80</td><td>DN50</td><td>200</td><td>Δp 16/ Δp 16</td></tr> <tr><td>25</td><td>31,25</td><td>0,156</td><td>0,250</td><td>160</td><td>DN50</td><td>200</td><td>Δp 16/ Δp 16</td></tr> <tr><td>25</td><td>31,25</td><td>0,100</td><td>0,160</td><td>250</td><td>DN50</td><td>200</td><td>Δp 16/ Δp 16</td></tr> <tr><td>25</td><td>31,25</td><td>0,0625</td><td>0,100</td><td>400</td><td>DN50</td><td>200</td><td>Δp 16/ Δp 16</td></tr> <tr><td>25</td><td>31,25</td><td>0,0312</td><td>0,050</td><td>800*</td><td>DN50</td><td>200</td><td>Δp 16/ Δp 16</td></tr> <tr><td>40</td><td>50,0</td><td>0,500</td><td>0,800</td><td>80</td><td>DN50</td><td>200</td><td>Δp 16/ Δp 40</td></tr> <tr><td>40</td><td>50,0</td><td>0,250</td><td>0,400</td><td>160</td><td>DN50</td><td>200</td><td>Δp 16/ Δp 40</td></tr> <tr><td>40</td><td>50,0</td><td>0,160</td><td>0,256</td><td>250</td><td>DN50</td><td>200</td><td>Δp 16/ Δp 40</td></tr> <tr><td>40</td><td>50,0</td><td>0,100</td><td>0,160</td><td>400</td><td>DN50</td><td>200</td><td>Δp 16/ Δp 40</td></tr> <tr><td>40</td><td>50,0</td><td>0,050</td><td>0,080</td><td>800*</td><td>DN50</td><td>200</td><td>Δp 16/ Δp 40</td></tr> </tbody> </table> <p>2. The meter has been supplemented with the following new modification with threaded end connection G2:</p> <table border="1" data-bbox="614 1473 1524 1630"> <thead> <tr> <th colspan="4">Flowrate, m³/h</th> <th rowspan="2">R, Q₃/Q₁</th> <th rowspan="2">End connections</th> <th rowspan="2">Length L, mm</th> <th rowspan="2">Pressure loss class: without filter/ with filter strainer</th> </tr> <tr> <th>Q₃</th> <th>Q₄</th> <th>Q₁</th> <th>Q₂</th> </tr> </thead> <tbody> <tr> <td>16</td> <td>20,0</td> <td>0,020</td> <td>0,032</td> <td>800*</td> <td>G 2</td> <td>300</td> <td>Δp 16/ Δp 16</td> </tr> </tbody> </table> <p>Note: * – this ratio is only valid for meters with temperature class T30.</p> <p>3. New software version 2.02 for meters with threaded end connection G 2.</p> <p>4. The document TM_QW1_V03_LT, issued 18-10-2021, has been replaced by the document TM_QW1_V04_LT, issued 07-12-2021.</p>	Flowrate, m ³ /h				R, Q ₃ /Q ₁	End connections	Length L, mm	Pressure loss class: without filter/ with filter strainer	Q ₃	Q ₄	Q ₁	Q ₂	16	20,0	0,200	0,320	80	DN50	200	Δp 16/ Δp 16	16	20,0	0,100	0,160	160	DN50	200	Δp 16/ Δp 16	16	20,0	0,064	0,102	250	DN50	200	Δp 16/ Δp 16	16	20,0	0,040	0,064	400*	DN50	200	Δp 16/ Δp 16	25	31,25	0,3125	0,500	80	DN50	200	Δp 16/ Δp 16	25	31,25	0,156	0,250	160	DN50	200	Δp 16/ Δp 16	25	31,25	0,100	0,160	250	DN50	200	Δp 16/ Δp 16	25	31,25	0,0625	0,100	400	DN50	200	Δp 16/ Δp 16	25	31,25	0,0312	0,050	800*	DN50	200	Δp 16/ Δp 16	40	50,0	0,500	0,800	80	DN50	200	Δp 16/ Δp 40	40	50,0	0,250	0,400	160	DN50	200	Δp 16/ Δp 40	40	50,0	0,160	0,256	250	DN50	200	Δp 16/ Δp 40	40	50,0	0,100	0,160	400	DN50	200	Δp 16/ Δp 40	40	50,0	0,050	0,080	800*	DN50	200	Δp 16/ Δp 40	Flowrate, m ³ /h				R, Q ₃ /Q ₁	End connections	Length L, mm	Pressure loss class: without filter/ with filter strainer	Q ₃	Q ₄	Q ₁	Q ₂	16	20,0	0,020	0,032	800*	G 2	300	Δp 16/ Δp 16
Flowrate, m ³ /h				R, Q ₃ /Q ₁	End connections	Length L, mm					Pressure loss class: without filter/ with filter strainer																																																																																																																																							
Q ₃	Q ₄	Q ₁	Q ₂																																																																																																																																															
16	20,0	0,200	0,320	80	DN50	200	Δp 16/ Δp 16																																																																																																																																											
16	20,0	0,100	0,160	160	DN50	200	Δp 16/ Δp 16																																																																																																																																											
16	20,0	0,064	0,102	250	DN50	200	Δp 16/ Δp 16																																																																																																																																											
16	20,0	0,040	0,064	400*	DN50	200	Δp 16/ Δp 16																																																																																																																																											
25	31,25	0,3125	0,500	80	DN50	200	Δp 16/ Δp 16																																																																																																																																											
25	31,25	0,156	0,250	160	DN50	200	Δp 16/ Δp 16																																																																																																																																											
25	31,25	0,100	0,160	250	DN50	200	Δp 16/ Δp 16																																																																																																																																											
25	31,25	0,0625	0,100	400	DN50	200	Δp 16/ Δp 16																																																																																																																																											
25	31,25	0,0312	0,050	800*	DN50	200	Δp 16/ Δp 16																																																																																																																																											
40	50,0	0,500	0,800	80	DN50	200	Δp 16/ Δp 40																																																																																																																																											
40	50,0	0,250	0,400	160	DN50	200	Δp 16/ Δp 40																																																																																																																																											
40	50,0	0,160	0,256	250	DN50	200	Δp 16/ Δp 40																																																																																																																																											
40	50,0	0,100	0,160	400	DN50	200	Δp 16/ Δp 40																																																																																																																																											
40	50,0	0,050	0,080	800*	DN50	200	Δp 16/ Δp 40																																																																																																																																											
Flowrate, m ³ /h				R, Q ₃ /Q ₁	End connections	Length L, mm	Pressure loss class: without filter/ with filter strainer																																																																																																																																											
Q ₃	Q ₄	Q ₁	Q ₂																																																																																																																																															
16	20,0	0,020	0,032	800*	G 2	300	Δp 16/ Δp 16																																																																																																																																											

1	2	3																																																																										
LT-1621-MI001-034 Revision 11	10-03-2022, No. LEI-12- MP-123.22	<p>1. The meter has been supplemented with this new modification of length $l = 115$ mm:</p> <table border="1" data-bbox="555 360 1465 792"> <thead> <tr> <th colspan="4">Flowrate, m³/h</th> <th rowspan="2">R, Q₃/Q₁</th> <th rowspan="2">End connections</th> <th rowspan="2">Length L, mm</th> <th rowspan="2">Pressure loss class: without filter/ with filter strainer</th> </tr> <tr> <th>Q₃</th> <th>Q₄</th> <th>Q₁</th> <th>Q₂</th> </tr> </thead> <tbody> <tr><td>1,6</td><td>2,0</td><td>0,020</td><td>0,032</td><td>80</td><td rowspan="12">G ¾</td><td rowspan="12">115*</td><td>Δp 16/ Δp 16</td></tr> <tr><td>1,6</td><td>2,0</td><td>0,010</td><td>0,016</td><td>160</td><td>Δp 16/ Δp 16</td></tr> <tr><td>1,6</td><td>2,0</td><td>0,0064</td><td>0,010</td><td>250</td><td>Δp 16/ Δp 16</td></tr> <tr><td>1,6</td><td>2,0</td><td>0,005</td><td>0,008</td><td>315</td><td>Δp 16/ Δp 16</td></tr> <tr><td>1,6</td><td>2,0</td><td>0,004</td><td>0,0064</td><td>400</td><td>Δp 16/ Δp 16</td></tr> <tr><td>2,5</td><td>3,125</td><td>0,031</td><td>0,050</td><td>80</td><td>Δp 25/ Δp 25</td></tr> <tr><td>2,5</td><td>3,125</td><td>0,0156</td><td>0,025</td><td>160</td><td>Δp 25/ Δp 25</td></tr> <tr><td>2,5</td><td>3,125</td><td>0,010</td><td>0,016</td><td>250</td><td>Δp 25/ Δp 25</td></tr> <tr><td>2,5</td><td>3,125</td><td>0,0062</td><td>0,010</td><td>400</td><td>Δp 25/ Δp 25</td></tr> <tr><td>2,5</td><td>3,125</td><td>0,0031</td><td>0,005</td><td>800</td><td>Δp 25/ Δp 25</td></tr> </tbody> </table> <p>Note: * – meters are produced only in the initial design version.</p> <p>2. Meter marking labels with the logos of new distributors (Annex 1p – distributors AQUAS NUEVAS, EWA, IREN, VandCenterSyd).</p> <p>3. The document TM_QW1_V04_LT, issued 07-12-2021, has been replaced by the document TM_QW1_V05_LT, issued 11-01-2022.</p>	Flowrate, m ³ /h				R, Q ₃ /Q ₁	End connections	Length L, mm	Pressure loss class: without filter/ with filter strainer	Q ₃	Q ₄	Q ₁	Q ₂	1,6	2,0	0,020	0,032	80	G ¾	115*	Δp 16/ Δp 16	1,6	2,0	0,010	0,016	160	Δp 16/ Δp 16	1,6	2,0	0,0064	0,010	250	Δp 16/ Δp 16	1,6	2,0	0,005	0,008	315	Δp 16/ Δp 16	1,6	2,0	0,004	0,0064	400	Δp 16/ Δp 16	2,5	3,125	0,031	0,050	80	Δp 25/ Δp 25	2,5	3,125	0,0156	0,025	160	Δp 25/ Δp 25	2,5	3,125	0,010	0,016	250	Δp 25/ Δp 25	2,5	3,125	0,0062	0,010	400	Δp 25/ Δp 25	2,5	3,125	0,0031	0,005	800	Δp 25/ Δp 25
Flowrate, m ³ /h				R, Q ₃ /Q ₁	End connections	Length L, mm					Pressure loss class: without filter/ with filter strainer																																																																	
Q ₃	Q ₄	Q ₁	Q ₂																																																																									
1,6	2,0	0,020	0,032	80	G ¾	115*	Δp 16/ Δp 16																																																																					
1,6	2,0	0,010	0,016	160			Δp 16/ Δp 16																																																																					
1,6	2,0	0,0064	0,010	250			Δp 16/ Δp 16																																																																					
1,6	2,0	0,005	0,008	315			Δp 16/ Δp 16																																																																					
1,6	2,0	0,004	0,0064	400			Δp 16/ Δp 16																																																																					
2,5	3,125	0,031	0,050	80			Δp 25/ Δp 25																																																																					
2,5	3,125	0,0156	0,025	160			Δp 25/ Δp 25																																																																					
2,5	3,125	0,010	0,016	250			Δp 25/ Δp 25																																																																					
2,5	3,125	0,0062	0,010	400			Δp 25/ Δp 25																																																																					
2,5	3,125	0,0031	0,005	800			Δp 25/ Δp 25																																																																					
LT-1621-MI001-034 Revision 12	20-09-2022, No. LEI-12- MP-128.22	<p>1. The following types of microcontrollers can be used in the meter:</p> <ul style="list-style-type: none"> - 16-bit microcontroller Renesas R5F10WMGAFB (in the meters of all modifications); - 32-bit microcontroller Nuvoton M258KE3AE (in meters with threaded end connection G ¾, G 1, G 1¼, G 1½). <p>2. New software version 3.01 for meters equipped with a Nuvoton M258KE3AE microcontroller.</p> <p>3. Meter marking labels with the logos of new distributors (Annex 1p – distributor TENNACOLA).</p>																																																																										
LT-1621-MI001-034 Revision 13	28-12-2022, No. LEI-12- MP-131.22	<p>1. The meter has been supplemented with a reverse flow measurement function.</p> <p>2. Meter marking labels with the logos of new distributors (Annex 1p – distributors Watercare, PAVIA ACQUE and GSA).</p> <p>3. Technical description TM_QW1_V05_LT, issued 11-01-2022, has been replaced by technical description PE_QW1_V13_EN, issued 12-2022.</p>																																																																										
LT-1621-MI001-034 Revision 14	25-01-2023, No. LEI-12- MP-132.23	<p>1. Meters with a permanent flow rate from Q₃ = 2,5 m³/h to Q₃ = 40 m³/h has been supplemented with a modification with a ratio Q₃/Q₁ (R) = 500.</p> <p>2. Technical description PE_QW1_V13_EN, issued 12-2022, has been replaced by technical description PE_QW1_V14_EN, issued 01-2023.</p>																																																																										
LT-1621-MI001-034 Revision 15	28-04-2023, No. LEI-12- MP-001.23	<p>Meter marking labels with the logos of new distributors (Annex 1p – distributors ABC, Heitland Leipzig, Heitland OOWV and AUSINO).</p>																																																																										



1	2	3
LT-1621- MI001-034 Revision 16	18-03-2024, No. LEI-12- MP-006.23	<ol style="list-style-type: none">1. Due to the change in the design of the DN50 measuring channel inserts, assembly drawing N10.0043.00-00, approved on 11-12-2020, has been replaced by assembly drawing N10.0043.00-00, approved on 13-02-2024.2. The pressure loss classes of the meter DN50 have changed.3. Meters can be produced by installing a 16-bit microcontroller Renesas R5F111PJGFB (in meters of all sizes).4. The data transmission protocols W-M-Bus-S1, W-M-Bus-C1 and SIGFOX are not used for the RF communication interfaces of the meter.5. New software version 4.01 for meters equipped with Renesas R5F111PJGFB microcontroller.6. The meter TEST instruction has been changed (clause 5.4).7. The Evides distributor label has been changed (Annex 1p (22)).8. Meter marking labels with the logos of new distributors (Fig.1p – distributors MAD MAYIM RIMONIM, AMAP, Uniaque, CWSA, ZAWA, SPDE, Viveracqua Acquavenete, Viveracqua ALTO TREVIGIANO SERVIZI, Viveracqua Veritas, Viveracqua Viacqua, Viveracqua Acque Veronesi, Viveracqua Piave Servizi, Viveracqua BIM, Viveracqua Azienda Gardesana, Viveracqua Livenza Tagliamento, ACQUAENNA, RUZZO Reti, Viveracqua AQUALATINA, Viveracqua AMAG, Heitland Freiburg, Gran Sasso, SEGMA Talete, CAM, Uznim, ALFA, Padania Acque).9. Technical description PE_QW1_V14_EN, issued 01-2023, has been replaced by technical description QW1_V16.5_EN, issued 14-03-2024.
LT-1621- MI001-034 Revision 17	30-12-2024, No. LEI-12- MP-001.24	<ol style="list-style-type: none">1. The ability to read the meter checksum CRC for software versions 1.01; 1.03; 3.01; 4.01 and 2.02, using auxiliary equipment (Annex 2p).2. New meter software versions displayed on the meter indicating device: 1.03.01; 4.01.01.3. Additional option with BC660 radio modem for NB-IoT communication interface.4. Additional option with degree of protection IP65.5. Meter marking labels with the logos of new distributors (Annex 1p – distributors IDEA GRIM, IDEA SICAM, IDEA VUS SPOLETO, Viveracqua AGS, Australian sub-metering, SGDD Langeland Vand ApS).6. The Heitland distributor label has been changed (Annex 1p (4)).



1	2	3
LT-1621- MI001-034 Revision 18	31-01-2025, No. LEI-12- MP-001.25	1. New meter software versions displayed on the meter indicating device: 1.03.02 ; 4.01.03 ; 4.01.04 . 2. UKCA mark on meter label (optional). 3. Meter marking label with new distributor's logo (Annex 1p (69) – distributor GRIDIA).
LT-1621- MI001-034 Revision 19	17-03-2025, No. LEI-12- MP-002.25	Meter marking labels with the logos of new distributors (Annex 1p – distributor AxFlow Vestby kommune (70) and distributor TARNBYFORSYNING (71)).

Handwritten signature

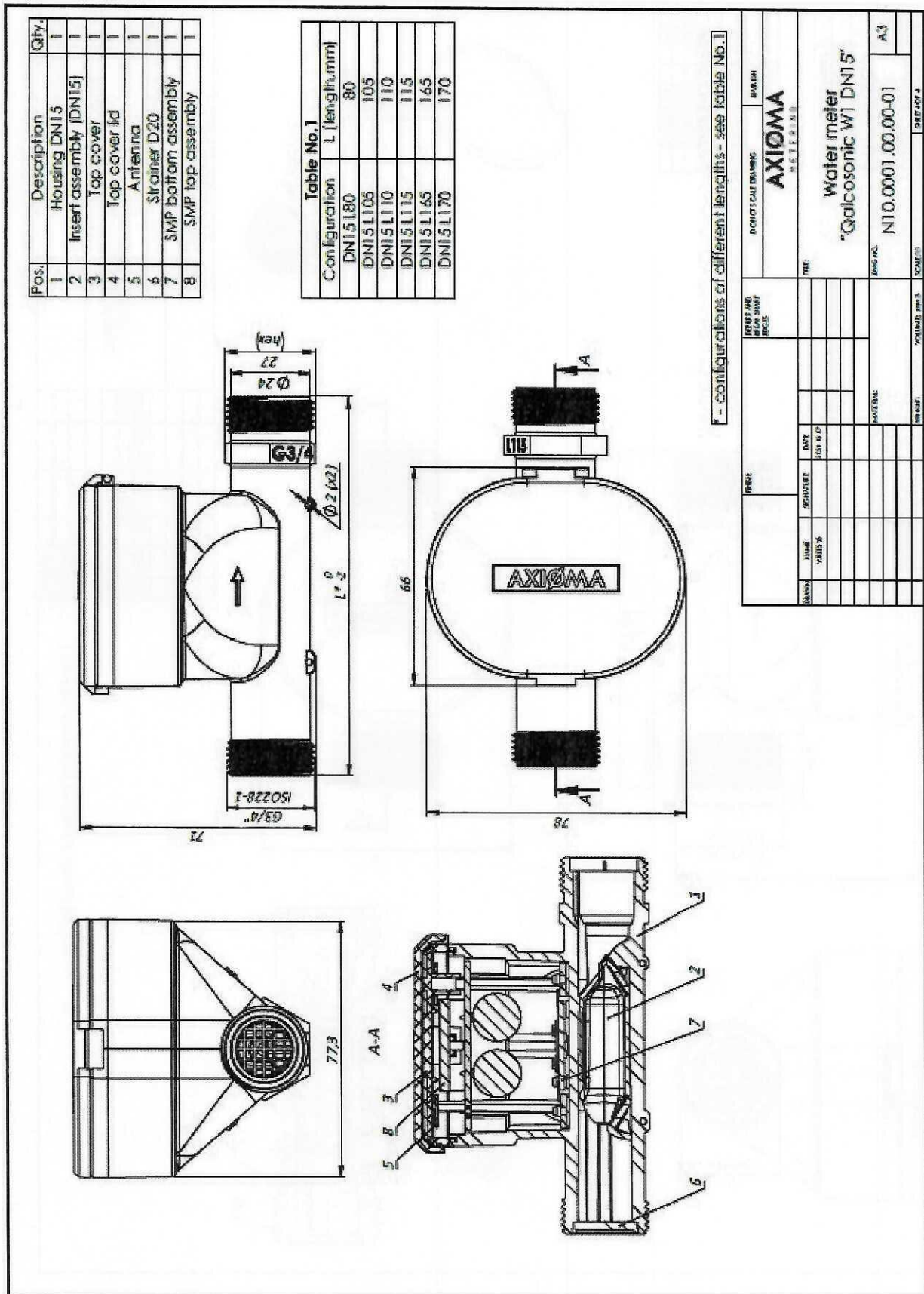

DRAWING		PROJECT	
DATE	SCALE	NO.	NAME
PROJECT NAME		PROJECT	
AXIOMA		AXIOMA	
TITLE		TITLE	
Water meter		Water meter	
"Galcosonic W1 DN15"		"Galcosonic W1 DN15"	
PROJECT NO.		PROJECT NO.	
N10.0001.00.00-01		N10.0001.00.00-01	
SCALE		SCALE	
A3		A3	



Pos.	Description	Qty.
1	Measuring DN20	1
2	Insert DN20	1
3	Top cover	1
5	Antenna	1
6	Sealing O-ring	1
8	SAF* topassy	1
11	Top cover lid	1

TABLE No. 1	l
CONFIGURATION (length),	mm
DN20 L105	105
DN20 L110	110
DN20 L130	130
DN20 L165	165
DN20 L190	190

N10.0013.00.00-01	
Water meter "QALCASONIC WI DN20"	kg 1:1
Lapas 1	Lapu 1
UAB "Axioma metering"	

Pad. Lapis	Dukum Nr.	Parasas	Data
Adika	V. Realytis		2024
Tilimo			
Nuorė			
Suderinti			
Parabė			

1. * - for configurations of different lengths see table No. 1

M. M. M.

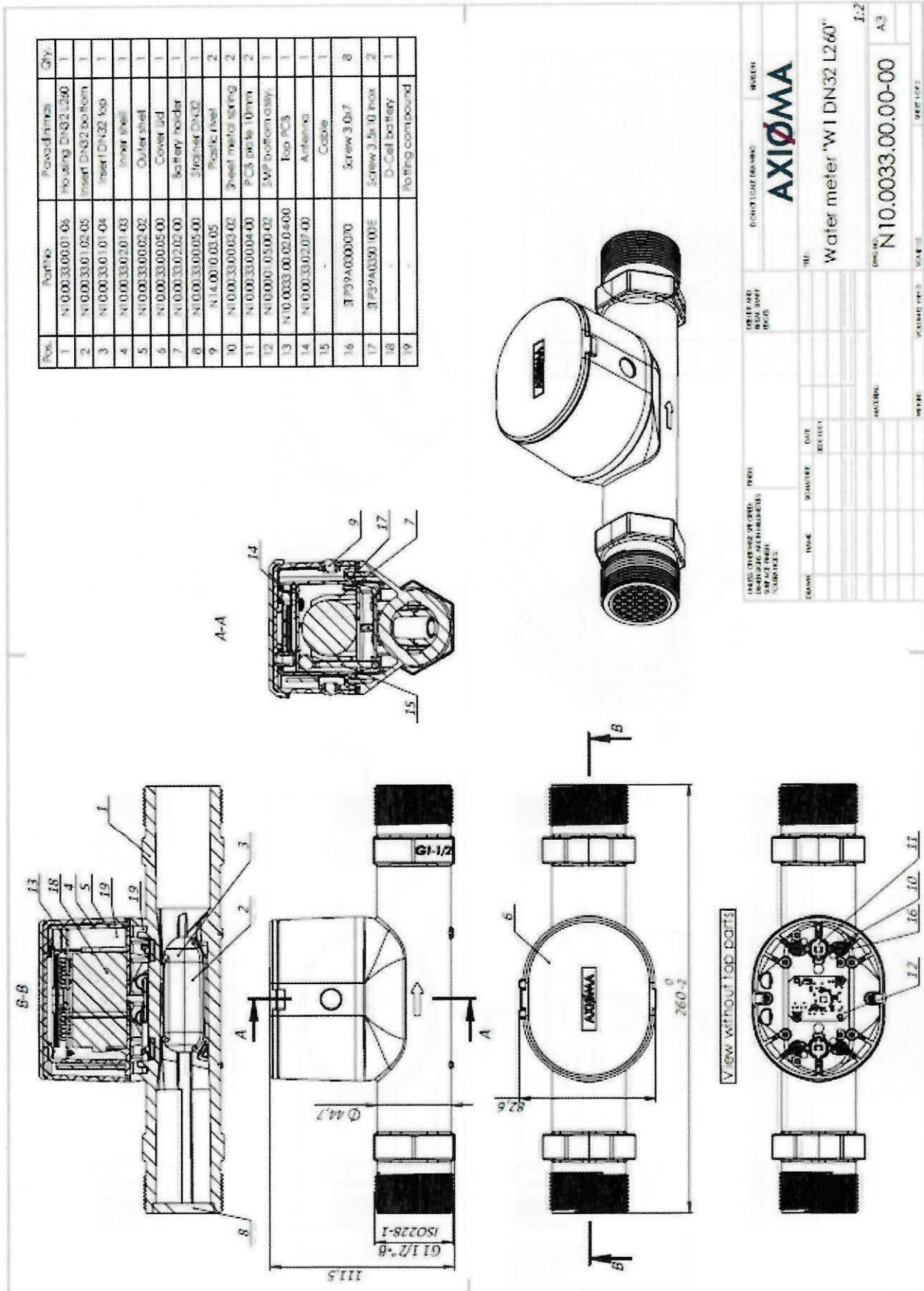

M. V. V.

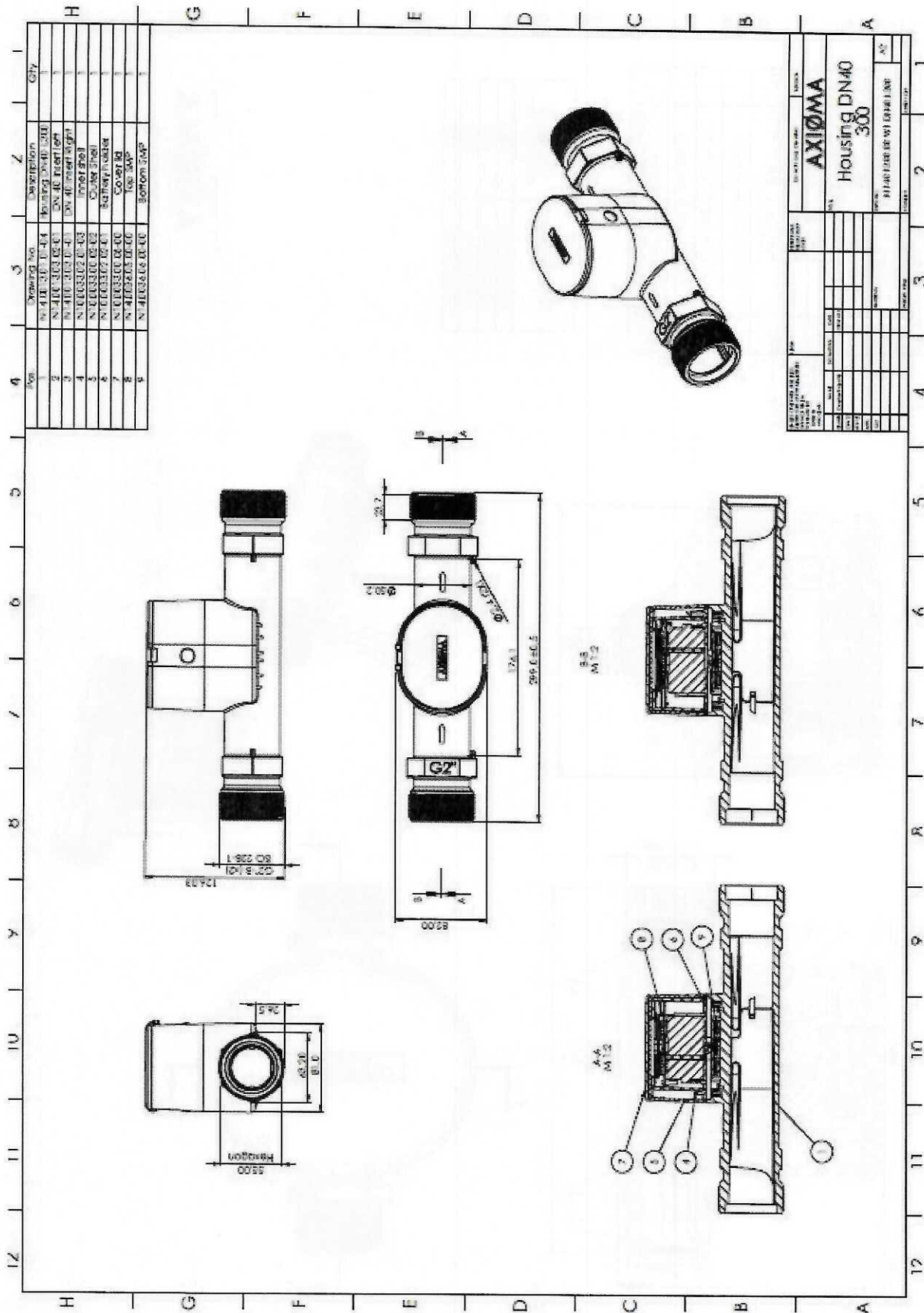

Handwritten signature

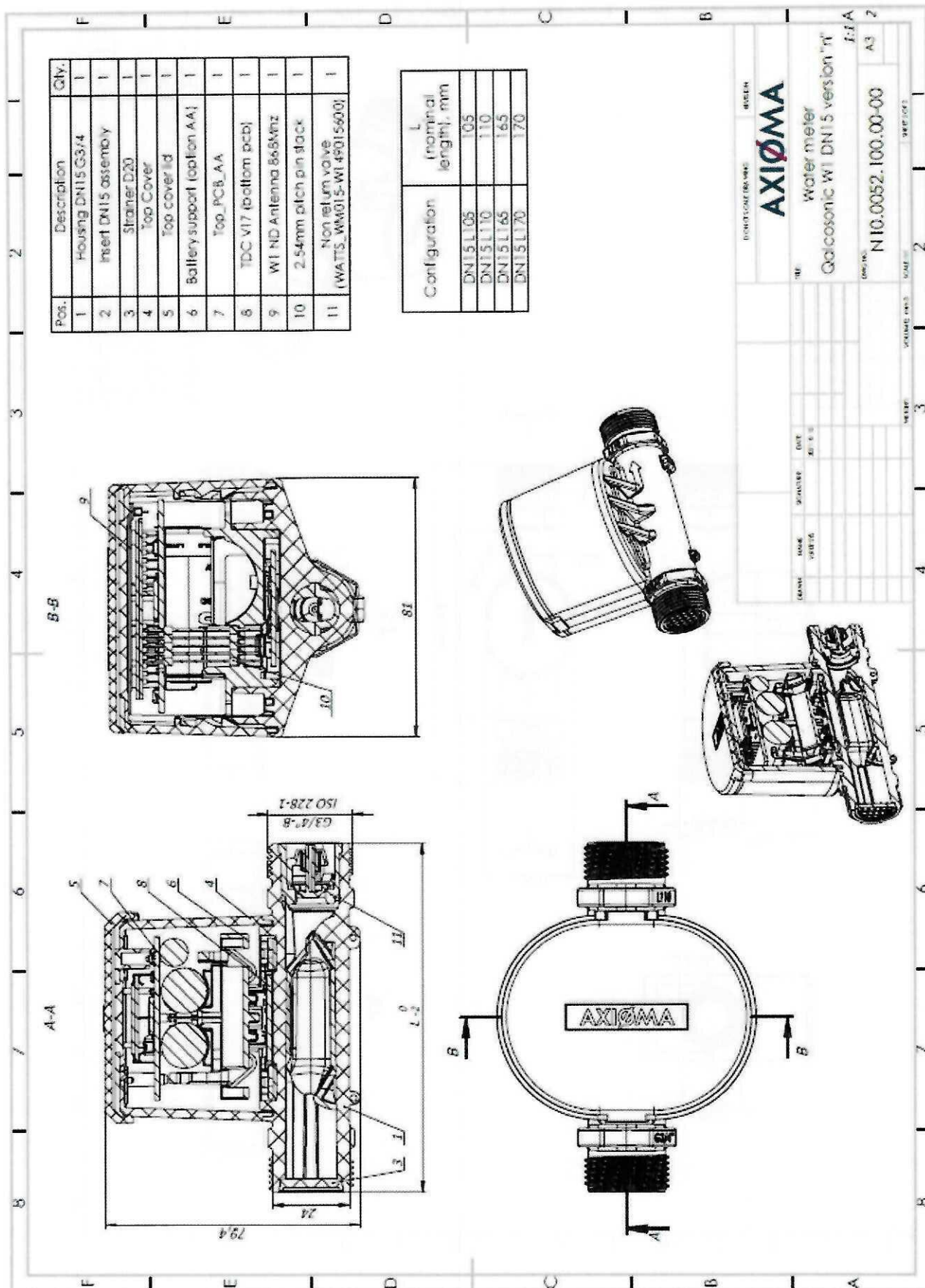

Malina



Annex 1p















Meter labels with distributor's logos

1) Distributor Neovac label	2) Distributor DIAM label	3) Distributor HT GROUP label
4) Distributor Heitland label	5) Distributor ADF label	6) Distributor AMAP label
7) Distributor OSE label	8) Distributor GSP label	9) Distributor EQUYSIS label
10) Distributor AQP label	11) Distributor SECAM label	12) Distributor RKG label
13) Distributor Hydro Control label	14) Distributor NSVA label	15) Distributor VASYD label











Amg

		
16) Distributor ASIS label	17) Distributor VERTO label	18) Distributor ETRA label
		
19) Distributor KIWA label	20) Distributor PUBLIACQUA label	21) Distributor ASA label
		
22) Distributor Evides label	23) Distributor acea label	24) Distributor APS label
		
25) Distributor AQUAS NUEVAS label	26) Distributor EWA label	27) Distributor IREN label
		
28) Distributor VandCenterSyd label	29) Distributor TENNACOLA label	30) Distributor Watercare label

31) Distributor GSA label	32) Distributor PAVIA ACQUE label	33) Distributor ABC label
34) Distributor Heitland Leipzig label	35) Distributor Heitland OOWV label	36) Distributor AUSINO label
37) Distributor MAD MAYIM RIMONIM label	38) Distributor AMAP label	39) Distributor Uniaque label
40) Distributor CWSA label	41) Distributor ZAWA label	42) Distributor SPDE label
43) Distributor Viveracqua Acquavenete label	44) Distributor Viveracqua ALTO TREVIGIANO SERVIZI label	45) Distributor Viveracqua Veritas label

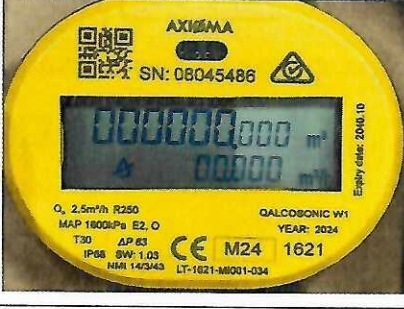
		
<p>46) Distributor Viveracqua Viacqua label</p>	<p>47) Distributor Viveracqua Acque Veronesi label</p>	<p>48) Distributor Viveracqua Piave Servizi label</p>
		
<p>49) Distributor Viveracqua BIM label</p>	<p>50) Distributor Viveracqua Azienda Gardesana label</p>	<p>51) Distributor Viveracqua Livenza Tagliamento label</p>
		
<p>52) Distributor ACQUAENNA label</p>	<p>53) Distributor RUZZO Reti label</p>	<p>54) Distributor Viveracqua ACQUALATINA label</p>
		
<p>55) Distributor Viveracqua AMAG label</p>	<p>56) Distributor Heitland Freiburg label</p>	<p>57) Distributor Gran Sasso label</p>
		
<p>58) Distributor SEGMA Taleta label</p>	<p>59) Distributor CAM label</p>	<p>60) Distributor Uznim label</p>



		
<p>61) Distributor ALFA label</p>	<p>62) Distributor Padania Acque label</p>	<p>63) Distributor IDEA GRIM label</p>
		
<p>64) Distributor IDEA SICAM label</p>	<p>65) Distributor IDEA VUS SPOLETO label</p>	<p>66) Distributor Viveracqua AGS label</p>
		
<p>67) Australian sub-metering label</p>	<p>68) Distributor SGDD Langeland Vand ApS label</p>	<p>69) Distributor GRIDIA label</p>
		
<p>70) Distributor AxFlow Vestby kommune label</p>	<p>71) Distributor TARNBYFORSYNING label</p>	

Handwritten signature

Annex 2p

CRC checksum values for software versions 1.01; 1.03; 3.01; 4.01 and 2.02

Software version	CRC*	Description
1.01	F9BA	G ¾ – G 1½, W-MBUS Communication Stack
1.01	78FA	G ¾ – G 1½, LoRa
1.01	85EA	G ¾ – G 1½, WMBUS Add AES-128 encryption for secure communication, ensuring compliance with privacy and data protection standards
1.01	3FD2	G ¾ – G 1½, LoRa, extended telegram structure implementation for US region
1.01	8B27	G ¾ – G 1½, implement support for S1 W-MBUS mode
1.01	3599	G ¾ – G 1½, critical alarms hysteresis implementation for US region
1.01	5872	G ¾ – G 1½, dynamic configuration of W-MBUS modes
1.01	5E8D	G ¾ – G 1½, LoRa, extended telegram structure implementation for AU region
1.01	6ABD	G ¾ – G 1½, critical alarms hysteresis implementation for IN region
1.01	DBCB	G ¾ – G 1½, remote configuration of parameters such as transmission intervals
1.01	96B2	G ¾ – G 1½, critical alarms hysteresis implementation for W-MBUS 433 MHz
1.01	8C04	G ¾ – G 1½, status bytes implementation for W-MBUS
1.01	D4AB	G ¾ – G 1½, supported events extension for W-MBUS status transmission
1.01	9026	G ¾ – G 1½, W-MBUS 433MHz frequency implementation
1.01	83DB	G ¾ – G 1½, new Payload structure option implementation
1.01	60D9	G ¾ – G 1½, implement support for T2 W-MBUS mode
1.01	BA40	G ¾ – G 1½, LoRa, extended telegram structure implementation
1.01	BBAF	G ¾ – G 1½, Payload structure reconfiguration option implementation
1.01	A5FE	G ¾ – G 1½, LoRa, extended telegram structure implementation for EU region
1.01	5AC8	G ¾ – G 1½, new parameter value implementation as an option for W-MBUS Payload
1.01	5F92	G ¾ – G 1½, critical alarms hysteresis improvements for EU region
1.01	F6D9	G ¾ – G 1½, LoRa, enhanced telegram structure implementation for EU region



Software version	CRC*	Description
1.03	78FA	LoRa, A design, G $\frac{3}{4}$ – G $1\frac{1}{2}$
1.03	BA40	LoRa, A design, G $\frac{3}{4}$ – G $1\frac{1}{2}$, extended telegram structure implementation
1.03	A5FE	LoRa, A design, G $\frac{3}{4}$ – G $1\frac{1}{2}$, extended telegram structure implementation for EU region
1.03	5E8D	LoRa, A design, G $\frac{3}{4}$ – G $1\frac{1}{2}$, extended telegram structure implementation for AU region
1.03	3FD2	LoRa, A design, G $\frac{3}{4}$ – G $1\frac{1}{2}$, extended telegram structure implementation for US region
1.03	9026	LoRa, A design, G $\frac{3}{4}$ – G $1\frac{1}{2}$, W-MBUS 433 MHz frequency implementation
1.03	F6D9	LoRa, A design, G $\frac{3}{4}$ – G $1\frac{1}{2}$, enhanced telegram structure implementation for EU region
1.03	3599	LoRa, A design, G $\frac{3}{4}$ – G $1\frac{1}{2}$, critical alarms hysteresis implementation for US region
1.03	6ABD	LoRa, A design, G $\frac{3}{4}$ – G $1\frac{1}{2}$, critical alarms hysteresis implementation for IN region
1.03	96B2	LoRa, A design, G $\frac{3}{4}$ – G $1\frac{1}{2}$, critical alarms hysteresis implementation for W-MBUS 433 MHz
1.03	5F92	LoRa, A design, G $\frac{3}{4}$ – G $1\frac{1}{2}$, Critical alarms hysteresis implementation for EU region
1.03	2647	LoRa, A design, G $\frac{3}{4}$ – G $1\frac{1}{2}$, extended telegram structure implementation for EU region
1.03	76E4	LoRa, A design, G $\frac{3}{4}$ – G $1\frac{1}{2}$, dynamic telegram structure implementation for EU region modification
1.03	8A85	LoRa, A design, G $\frac{3}{4}$ – G $1\frac{1}{2}$, telegram with weekly archives structure implementation for EU region
1.03	6991	LoRa, A design, G $\frac{3}{4}$ – G $1\frac{1}{2}$, radio activation on the scheduled day functionality for EU region
1.03	B9C8	LoRa, A design, G $\frac{3}{4}$ – G $1\frac{1}{2}$, radio activation on the scheduled day functionality for AU region
1.03	6B8B	LoRa, A design, G $\frac{3}{4}$ – G 1 telegram resending registry implementation
1.03	5E4E	LoRa, A design, G $\frac{3}{4}$ – G $1\frac{1}{2}$, implementation for AS region, subregions AS-1/ AS-4
1.03	3F94	LoRa, A design, G $\frac{3}{4}$ – G $1\frac{1}{2}$, radio activation on the scheduled day functionality for US region
1.03	22B4	LoRa, A design, G $\frac{3}{4}$ – G $1\frac{1}{2}$, implementation of the high temperature event
1.03	1E5E	LoRa, A design, G $\frac{3}{4}$ – G $1\frac{1}{2}$, adaptation of radio activation conditions to imperial units of measurement
1.03	078A	LoRa, A design, G $\frac{3}{4}$ – G $1\frac{1}{2}$, implementation of the battery life parameter into the W-MBUS telegram structure
1.03	E638	LoRa, A design, G $\frac{3}{4}$ – G $1\frac{1}{2}$, implementation of accident mode functionality for EU region



Software version	CRC*	Description
1.03	2556	LoRa, A design s, G $\frac{3}{4}$ – G $1\frac{1}{2}$, enhancement of accident mode functionality for EU region
1.03	F47B	LoRa, A design, G $\frac{3}{4}$ – G $1\frac{1}{2}$, implementation of sending short telegrams according to the relevant conditions of communication
1.03	AE78	LoRa, A design, G $\frac{3}{4}$ – G $1\frac{1}{2}$, implementation of additional conditions to send short telegrams
1.03	D1F6	LoRa, A design, G $\frac{3}{4}$ – G $1\frac{1}{2}$, implementation for AS region, subregions AS-3 /AS-4
1.03	F15E	LoRa, A design, G $\frac{3}{4}$ – G $1\frac{1}{2}$, implementation of the telegram algorithm for the UZ region
1.03	FE41	LoRa, A design, G $\frac{3}{4}$ – G $1\frac{1}{2}$, implementation of possibility to configure the reporting annual value into the structure of the W-MBUS Telegram
1.03	6D94	LoRa, A design, G $\frac{3}{4}$ – G $1\frac{1}{2}$, implementation accident mode functionality for the AS region
1.03	D4CC	LoRa, A design, G $\frac{3}{4}$ – G $1\frac{1}{2}$, enhancement of accident mode functionality for AS region
1.03	F083	LoRa, A design, G $\frac{3}{4}$ – G $1\frac{1}{2}$, improvements to radio activation on the scheduled day functionality
1.03	965A	LoRa, B design, G $\frac{3}{4}$ – G 1, installing/transferring functionalities from A DIZ version EU868
1.03	A38B	LoRa, B design, G $\frac{3}{4}$ – G 1, implementation of radio activation on the scheduled day for a modification of the EU region
1.03	6B49	LoRa, B design, G $\frac{3}{4}$ – G 1, extended telegram functionality for the IN region
1.03	C07B	LoRa, B design, G $\frac{3}{4}$ – G 1, implementation of accident mode functionality for EU region
1.03	1578	LoRa, B design, G $\frac{3}{4}$ – G 1, extended telegram functionality for EU region
1.03	F951	LoRa, B design G $\frac{3}{4}$ – G 1, enhancement of accident mode functionality for EU region
1.03	FF63	LoRa, B design, G $\frac{3}{4}$ – G 1, implementation of the telegram algorithm for the UZ region
1.03	ABFD	NB-IoT, A design, G $\frac{3}{4}$ – G $1\frac{1}{2}$
1.03	12C2	NB-IoT, A design, G $\frac{3}{4}$ – G $1\frac{1}{2}$, communication credits implementation
1.03	5C02	NB-IoT, A design, G $\frac{3}{4}$ – G $1\frac{1}{2}$, $\frac{1}{2}$, new telegram structure implementation
1.03	1D01	NB-IoT, A design, G $\frac{3}{4}$ – G $1\frac{1}{2}$, network condition parameters implementation in NB-IoT telegram structure
1.03	00B7	NB-IoT, A design s, G $\frac{3}{4}$ – G $1\frac{1}{2}$, telegram structure with Min/Max flow rates implementation
1.03	58CD	NB-IoT, A design, G $\frac{3}{4}$ – G $1\frac{1}{2}$, telegram structure capability improvement
1.03	660B	NB-IoT, A design, G $\frac{3}{4}$ – G $1\frac{1}{2}$, PSM timers configuration for NB modems
1.03	A3BE	NB-IoT, A design, G $\frac{3}{4}$ – G $1\frac{1}{2}$, implementation of critical alarm hysteresis
1.03	C705	NB-IoT, A design, G $\frac{3}{4}$ – G $1\frac{1}{2}$, installing accident mode functionality



Software version	CRC*	Description
1.03	F897	NB-IoT, B design, G ¾ – G 1, installing/transferring functionalities from A DIZ version NB-IoT
3.01	BC74	LoRa, A/B design, G ¾ – G 1, Nuvoton microcontroller M258KE3AE
3.01	2340	LoRa, A/B design, G ¾ – G 1, Nuvoton microcontroller r M258KE3AE, telegram with weekly archives structure implementation for EU region
3.01	2141	LoRa, A/B design, G ¾ – G 1, Nuvoton microcontroller r M258KE3AE, radio activation on the scheduled day functionality for US region
3.01	BE5A	LoRa, A/B design, G ¾ – G 1, Nuvoton microcontroller r M258KE3AE, implementation for AS region, subregions AS-1/ AS-4
3.01	ECF2	LoRa, A/B design, G ¾ – G 1, Nuvoton microcontroller r M258KE3AE, implementation of accident mode functionality for EU region
3.01	EACB	LoRa, A/B design, G ¾ – G 1, Nuvoton microcontroller r M258KE3AE, implementation of possibility to configure the reporting annual value into the structure of the W-MBUS Telegram
3.01	8D21	LoRa, A/B design, G ¾ – G 1, Nuvoton microcontroller r M258KE3AE, enhancement of Accident mode functionality for EU region
4.01	0959	NB-IoT, G 2 – DN50, telegram structure with Min/Max flow rates implementation
4.01	61F7	LoRa, G 2 – DN50, implementation of accident mode functionality
4.01	13A0	LoRa, G 2 – DN50, implementation of possibility to configure the reporting annual value into the structure of the WMBUS Telegram
2.02	B300	NB-IoT, G 2 – DN50, implementation of critical alarm hysteresis
2.02	9805	NB-IoT, G 2 – DN50, new telegram structure implementation
2.02	5D8B	NB-IoT, G 2 – DN50, communication credits implementation
2.02	4DD8	NB-IoT, G 2 – DN50, telegram structure capability improvement
2.02	9B08	NB-IoT, G 2 – DN50, network condition parameters implementation in NB-IoT telegram structure
2.02	5909	NB-IoT, G 2 – DN50, telegram structure with Min/Max flow rates implementation
2.02	0FD3	LoRa, G 2 – DN50
2.02	ED7C	LoRa, G 2 – DN50, implementation of radio activation on the scheduled day for a modification of the EU region
2.02	D061	LoRa, G 2 – DN50, implementation for AS region, subregions AS-1/AS-4
2.02	61F7	LoRa, G 2 – DN50, implementation of accident mode functionality
2.02	13A0	LoRa, G 2 – DN50, implementation of possibility to configure the reporting annual value into the structure of the W-MBUS telegram

* – the „uint16“(HEX) variable is read from 0x103C address.

